

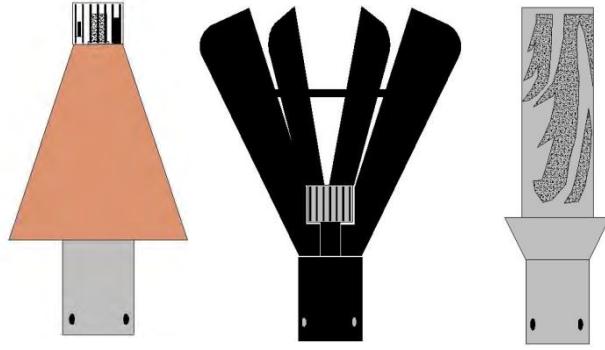

www.FirebyDesign.com



Automated Tiki Torch (AWEIS) Owner's Manual Installation and Operation

Certified by
Lab Test Certification
Meets: ANSI Z21.97-2014
CSA 2.41-2014
CSA C22.2 No. 3-M1998 (R2014)

⚠ WARNING ⚠

Improper installation, adjustment, alteration, service or maintenance can cause injury or property damage. Read the installation, operating and maintenance instructions thoroughly before installing or servicing this equipment.

⚠ WARNING ⚠

Do not store or use gasoline or other flammable vapors and liquids in vicinity of this or any other appliance.

An LP-cylinder not connected for use shall not be stored in the vicinity of this or any other appliance.

⚠ WARNING ⚠

**FOR OUTDOOR
USE ONLY**

⚠ DANGER



CARBON MONOXIDE HAZARD

This appliance can produce carbon monoxide which has no odor.

Using it in an enclosed space can kill you.

Never use this appliance in an enclosed space such as a camper, tent car or home.

⚠ WARNING ⚠

For Use with NATURAL or LP GAS Only
NO SOLID FUELS TO BE USED WITH THIS SYSTEM

⚠ DANGER ⚠

If you smell gas:

1. Shut off gas to the appliance.
2. Extinguish any open flame.
3. If odor continues, keep away from appliance and immediately call your gas supplier or fire department.

Installation must conform with local codes or, in the absence of local codes, with the *National Fuel Gas Code, ANSI Z223.1 / NFPA 54, or International Fuel Gas Code.*

The appliance, when installed, must be electrically grounded in accordance with local codes or, in the absence of local codes, with the *National Electric Code, ANSI/NFPA 70, if applicable.*

INSTALLER: Leave this manual with the appliance.
CONSUMER: Retain this manual for future reference.

⚠ Proposition 65 Warning ⚠

Operating, servicing and maintaining this appliance can expose you to chemicals including Carbon Monoxide and Lead which are known to the State of California to cause cancer, birth defects or other reproductive harm. For more information go to www.Prop65Warnings.ca.gov

⚠ AVERTISSEMENT ⚠

Une installation, un ajustement, une modification, une réparation ou un entretien inapproprié peuvent être la cause de blessures ou de dommages. Veuillez lire attentivement les instructions d'installation, d'utilisation et d'entretien avant d'installer ou de réparer ce matériel.

⚠ AVERTISSEMENT ⚠

Ne pas entreposer ni utiliser de l'essence ni d'autres vapeurs ou liquides inflammables dans le voisinage de l'appareil, ni de tout autre appareil.

Une bouteille de propane qui n'est pas raccordée en vue de son utilisation, ne doit pas être entreposée dans le voisinage de cet appareil ou de tout autre appareil.

⚠ AVERTISSEMENT ⚠

Pour utilisation
à l'extérieur seulement.

⚠ DANGER



MONOXYDE DE CARBONE
Cet appareil peut produire du monoxyde de carbone, un gaz inodore.

L'utilisation de cet appareil dans des espaces clos peut entraîner la mort.

Ne jamais utiliser cet appareil dans un espace clos comme un véhicule de camping, une tente, une automobile ou une maison.

⚠ AVERTISSEMENT ⚠

Pour utilisation avec naturel ou propane ne gaz seulement
Aucun combustibles solides pour être utilisés avec ce système

⚠ DANGER ⚠

S'il y a une odeur de gaz:

1. Coupez l'admission de gaz de l'appareil.
2. Éteindre toute flamme nue.
3. Si l'odeur persiste, éloignez-vous de l'appareil et appelez immédiatement le fournisseur de gaz ou le service d'incendie.

⚠ AVERTISSEMENT ⚠

Ne pas utiliser cet appareil s'il a été plongé, même partiellement, dans l'eau. Appeler un technicien qualifié pour inspecter l'appareil et remplacer toute partie du système de commande et toute commande qui a été plongée dans l'eau.

Table of Contents

Gas and Electrical Requirements	Page 4
Clearance from Combustibles	Page 4
Installation	Page 5
Daisy Chain Wiring	Page 9
Operation	Page 10
Maintenance	Page 11
Replacement Parts	Page 11
Troubleshooting	Page 12

Gas Requirements

Fuel Type – Before making gas connections ensure appliance being installed is compatible with the available gas type. Check the label on the appliance to confirm appliance gas type requirement.

Gas Pressure – Proper input gas pressures are required for optimum appliance performance.

Gas Pressure Requirements

Pressure	Natural Gas	Propane
Minimum	3.5" W.C.	8.0" W.C.
Nominal	7.0" W.C.	11.0" W.C.
Maximum	½ psi (14.0" W.C.)	½ psi (14.0" W.C.)

Electrical Requirements

⚠ WARNING ⚠

The All Weather Electronic Ignition System operates on 24 Volts AC power ONLY
DO NOT Attempt to Power using 110 Volts AC Power – Damage WILL RESULT

Acceptable Input Voltages to Supplied 24 Volt AC Transformer

110 / 210 / 220 / 240 / 480 Volt AC

(Supplied 24 Volt AC Transformer compatible with all voltages listed above)

(Read label on supplied transformer for proper connection information)

Recommended Wire Size

12 gauge wire for all installations

Clearance from Combustibles

⚠ WARNING – FIRE RISK ⚠

Provide Adequate Clearance from Combustibles as shown below

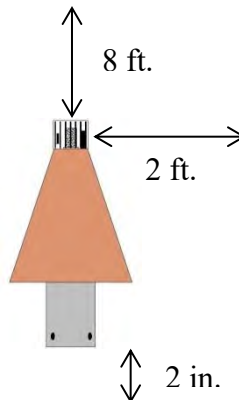

Installation

Note: Installation should be done by a qualified service technician that is locally licensed.

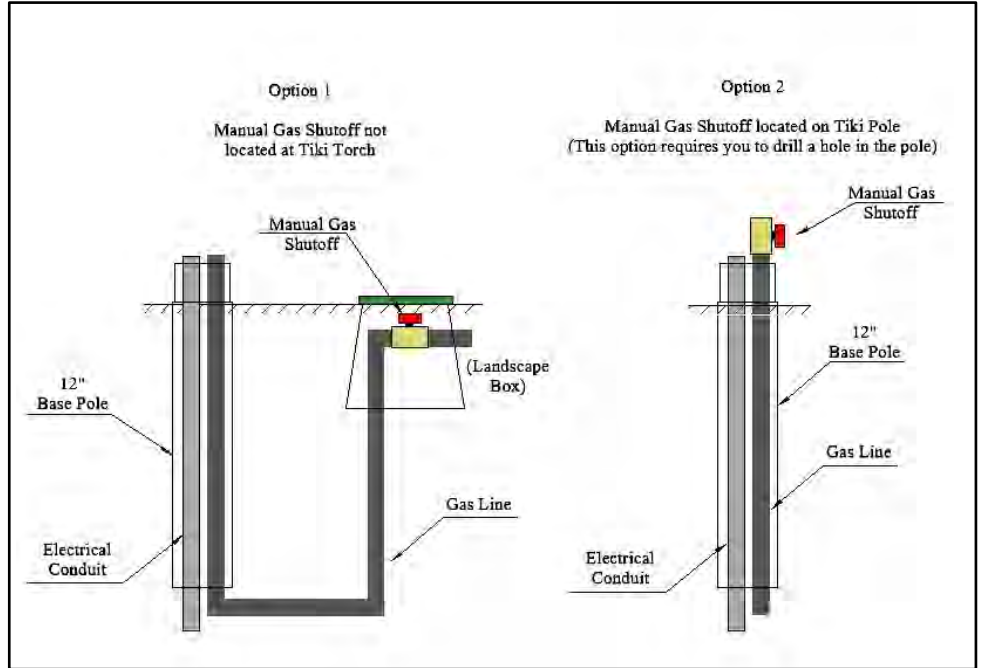
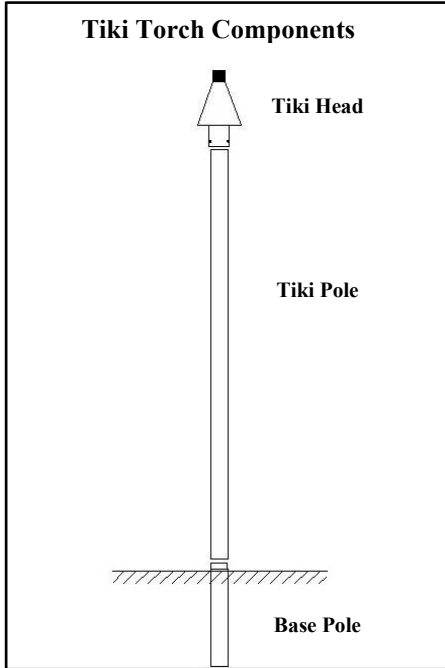

Installation of Base Pole

Step 1

At right is a photo of 1/2" gas stub and an electrical conduit stubbed up inside a hole made by a post hole digger. The hole is 12" deep. The wire installed inside the conduit was low voltage landscape wire (12 gauge) and we pulled 8' of wire beyond the end of the conduit to have plenty to pull up through the poles in the Tiki.

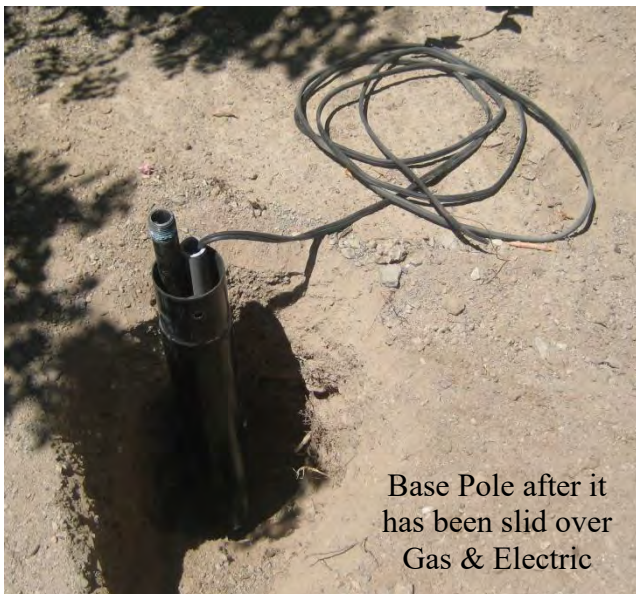
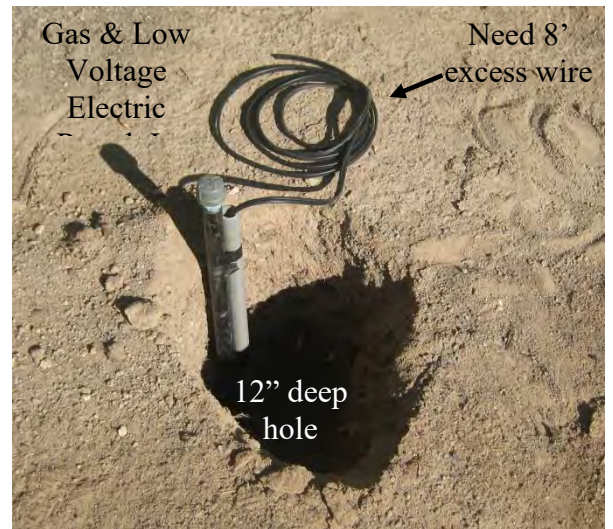

Step 2

At left we fished the wire through the Base Pole and slid it over the Gas & Electric stubs. Notice we adjusted the height of the Base Pole so that the tapered top end of the Base Pole ended up above grade. This we did to make the connection between the Base Pole and the Tiki Pole easier later on.

Note: If you are NOT locating the Manual Gas Shutoff ON the Tiki Pole skip to Step 5 below

Step 3

If you are installing the Manual Gas Shutoff on the Tiki Pole (Option 2 from page 4) first remove the handle from the Ball Valve and then install the ball valve on the 1/2" gas riser as shown in the photo at right. The use of pipe dope or Gas Teflon tape is highly recommended to prevent a possible gas leak.

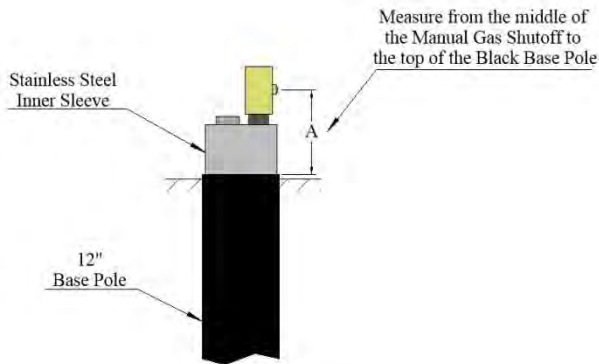

Step 4

Once the Manual Gas Shutoff is installed measure from the center of the Gas Shutoff to the top of the Black Base Pole. This dimension we shall refer to as measurement "A".

Step 5

Temporarily install the longer tiki pole and measure from the seam between the Base Pole and the top of the long tiki pole. This dimension we will refer to as measurement "B".

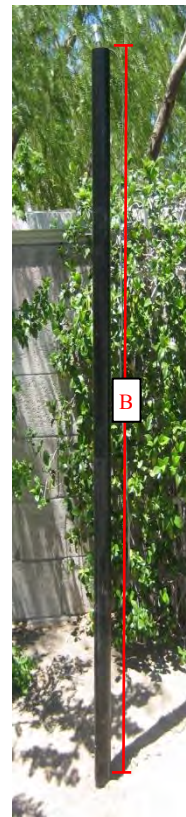

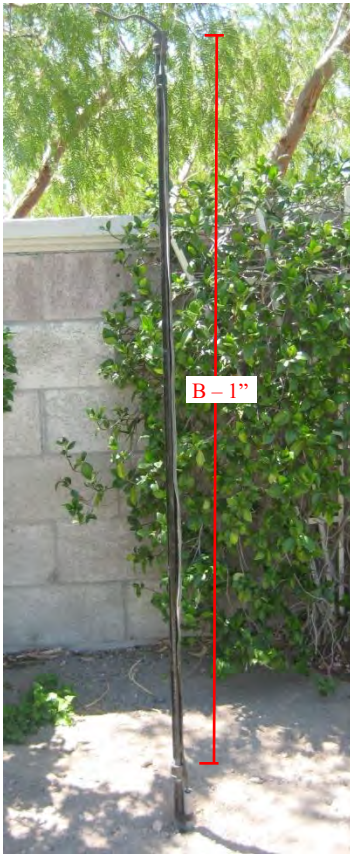

Step 6

Install $\frac{1}{2}$ " gas line to your gas riser (or manual gas shutoff valve) such that the end of the $\frac{1}{2}$ " gas line is 1" SHORTER than measurement "B" from the previous page. In addition, bring the wires previously installed up along the gas line and tape it to the gas line in anticipation of installing the longer tiki pole.

Step 7

Measure from the bottom of the long tiki pole up to measurement "A" and mark the pole. Then drill a 1" diameter hole in the side of the pole for the Manual Gas Shutoff Valve.



Step 8

Next install the Manual Gas Shutoff Valve as shown in photo at left.

Installing the Tiki Torch Head



Step 9

In the photo at left you are looking at a close up of the bottom of the Tiki Torch Head. Unless a custom configuration is requested there will be the 2 wires as shown along with a 1/2" coupling.

Step 10

Attach the wires from the tiki torch head to the 2 wires coming up inside the center of the pole. We recommend wrapping the wires that are coming up through the pole counter clockwise around the gas line 3 full turns in anticipation of threading the tiki head onto the gas line.



Step 11

Thread the tiki torch head onto the tiki pole and then secure by tightening the 3 set screws in the base of the tiki torch head.

Daisy Chain Wiring of Tiki Torches

When wiring tiki torches in series (aka “Daisy Chain” Wiring) it is important to keep the polarity BETWEEN the tiki torches the same. Protruding from the bottom of the Tiki Torch head are two wires: a “White” wire and a “White/Blue” wire. These are the power wires.

In the illustration below you see two tiki torch heads with a Black wire and a Blue Wire. Due to the fact you would not be able to see a “White” wire on this page we substituted it with a Black wire in the illustration. If you look closely, the Black wire from BOTH tiki torches are connected to the same (orange) wire and the Light Blue wire from BOTH tiki torches are connected to the same (dark blue) wire.

When Daisy Chaining two or more tiki torches this wiring method must be followed.
No more than 4 Tiki Torches are to be daisy chained together.

Polarity between the tiki torches and the transformer DOES NOT matter. ONLY the polarity BETWEEN the tiki heads matters.

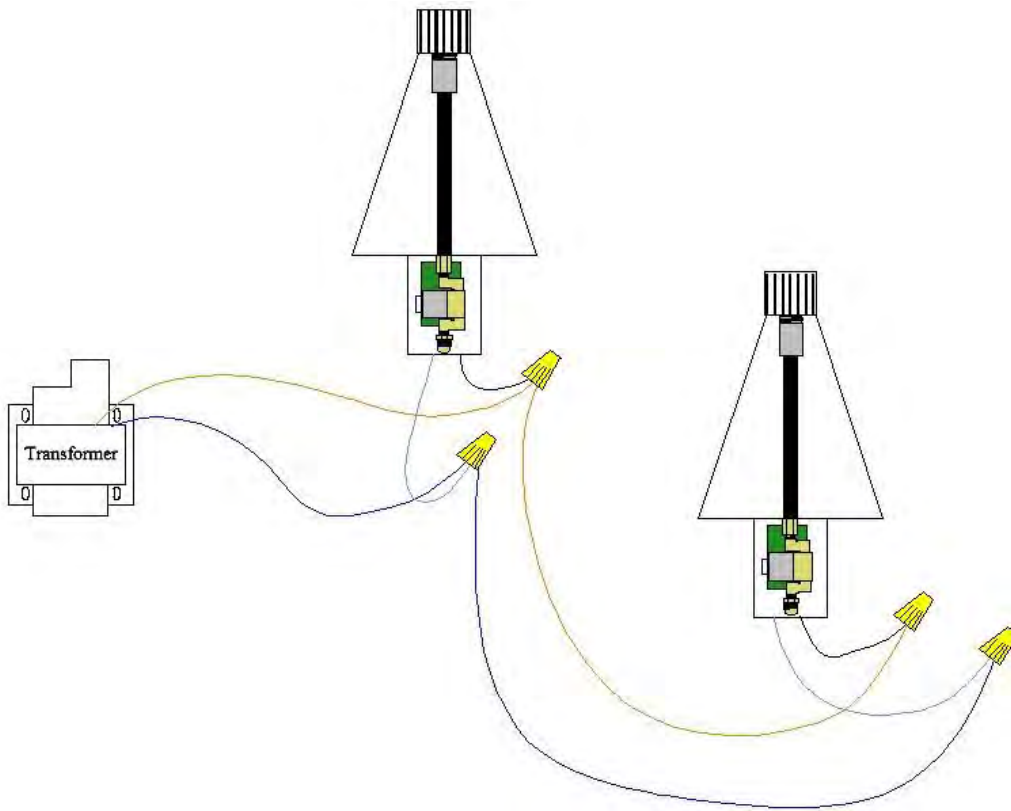

Operation

⚠ WARNING ⚠

Do NOT use this appliance if any part has been under water.
Immediately call a qualified service technician to inspect the appliance and to replace any part of the control system and any gas control which has been under water.

⚠ WARNING ⚠

HOT – DO NOT TOUCH - SEVERE BURNS MAY RESULT - CLOTHING IGNITION MAY RESULT

- CAREFULLY SUPERVISE children in same area as the appliance.
- Alert children and adults to hazards of high temperatures.
- Clothing or other flammable materials should not be hung from the appliance or placed on or near the appliance.

⚠ WARNING ⚠

The appliance should be inspected before use and at least annually by a qualified service technician.

Any guard or protective device removed for servicing must be replaced prior to operation.

Keep the appliance area clear and free from combustible materials, gasoline and other flammable vapors and liquids.

Fire Feature Start Up

1. Prior to turning appliance on visually inspect fire feature to ensure debris such as leaves or other combustible material has not collected inside the feature which could burn and emit embers once the fire feature is turned on. Also ensure any person standing close to the fire feature is aware you will be turning the fire feature on prior to actually turning it on.
2. Turn fire feature on by turning on the electrical device used to power the fire feature.

Sequence of Operation during Ignition

- Power is applied
- Hot Surface Igniter (Glow Plug) becomes hot and 4 seconds later the Gas Valve opens
- Within 10 seconds of power application Flame should be visible (at night only)

Fire Feature Shutdown

1. Turn fire feature off by turning off the electrical device used to power the fire feature.

⚠ WARNING ⚠

If fire feature fails to turn off completely (small flames still visible)
Turn off gas supply using the manual gas shutoff.

Maintenance

⚠ WARNING ⚠

Maintenance should be done by a qualified service technician.
The appliance should be inspected before use and at least annually by a qualified service technician.

⚠ WARNING ⚠

Ensure gas and power are shut off and appliance is cool before servicing.

⚠ WARNING ⚠

Any guard or protective device removed for servicing must be replaced prior to operation.

Prior to Each Use

1. Inspect for debris in Fire Feature – remove debris prior to use

Semi-Annually

1. Visually inspect Pilot Burner for debris/insect infestation (spider webs)
2. Visually inspect burner for debris/insect infestation
3. Clean either of the above as necessary using compressed air.

Annually

1. Visually inspect Burner for excess corrosion due to heat and moisture.
2. Turn fire feature on to ensure proper operation.

Replacement Parts

Item Letter	Part Name	Part #
A	Wind Cap	WC
B	Burner	TB
C	Thermal Sensor	TTS
D	Hot Surface Igniter	HSI
E	Gas Valve	TGV
F	FBD Controller	FBDC

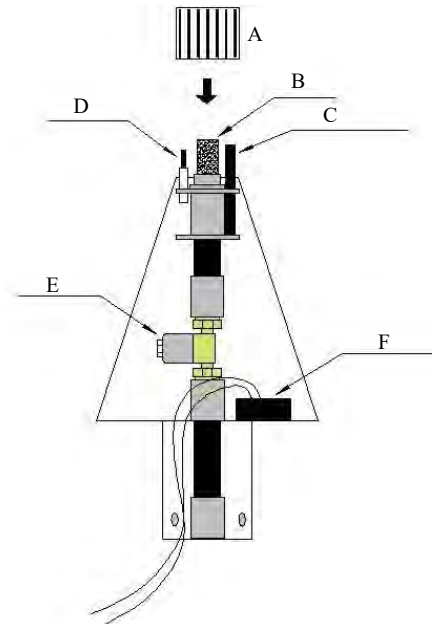

Troubleshooting

I installed the Tiki Torch turned it on and nothing happened

When this occurs it is usually due to an electrical wiring / power issue. Check all your electrical connections thoroughly to ensure all wires at the transformer and inside the fire feature are connected properly. If it appears all wiring is connected properly, disconnect the wires at the fire feature, attach a Multimeter to the wires to confirm a minimum of 24 volts when the fire feature is turned on. If you determine that you do not have a minimum of 24 volts at the fire feature conduct the same test at the transformer to ensure the transformer is in fact producing a minimum of 24 volts. If you do have a minimum of 24 volts at the fire feature contact us for further assistance.

I installed the Tiki Torch, turned it on and I can see the glow plug glowing orange and I can hear gas flowing but it will not ignite.

There are two possible causes to this problem; **Air in the Gas Line** or not enough **Electrical Current** to the fire feature.

Air in the Gas Line. If a new gas line was installed and the air was never purged from it prior to installing the Electronic Ignition System then it may take several times of turning the fire feature on and off before the air is purged from the gas line. Here is how our system works; after you turn it on the glow plug will come on first followed by the Pilot Gas Valve opening 4 seconds later. For the next 180 seconds (3 minutes) the glow plug will cycle on and off every 30 seconds while the Pilot Gas Valve will remain on the entire time. Therefore if you are attempting to purge air from the gas line, turn the system on and leave it on for approximately 3 minutes. Then turn it off and then back on (no need to wait to turn it back on). Let the system run for another 3 minutes. Usually when purging air from a new gas line you will need to cycle the power several times as described above before gas begins to flow. If at any point you smell gas but still don't have ignition, attempt to light the Pilot flame with a handheld lighter. If the flame ignites when you light it by hand, go to the section below, "Electrical Current".

Electrical Current. If you have determined that air in the gas line is not the problem then most likely the failure to ignite is due to the fact the glow plug is not getting hot enough to ignite the gas. The reason a glow plug will not get hot enough is due to the fact it is not getting enough 'amps'. Often times when troubleshooting electricians will check the electrical power and when they see they have a minimum of 24 volts they think everything is fine electrically so there must be a problem with the Electronic Ignition System. The problem is not due to the volts but rather the amps. The number of amps reaching the fire feature is heavily dependent on the gauge wire used between the transformer and the fire feature. Our Install Instructions require no less than 12 gauge wire be run for all fire features. Often times we learn that in many cases less than 12 gauge wire has been used and herein lies the cause of the problem.

Here is how you check to determine if enough Electrical Current (amps) are getting to the fire feature:

1. CAUTION: Turn off the gas supply prior to the next step.
2. Using a clamp on ammeter, clamp the ammeter around one of the wires providing power to the Electronic Ignition System.
3. Turn the fire feature on.
4. The amps you should see will range between 1.4 to 1.6 amps initially. Four seconds after being turned on the amps will jump to approximately 2.0 amps.

If you do not see the amps listed above AND the wire gauge used was less than 12 gauge wire – change the wiring. Otherwise contact us for further assistance.

I turned the Tiki Torch off but I still see small flames emanating from the fire feature.

Turn the fire feature on, let the main fire ring light and then turn it off again – do this several times. Small pieces of debris from the gas line can get caught in the main or pilot valve thereby preventing it from closing all the way. This will

sometimes happen with a new gas line. By cycling power you can often times dislodge the debris. If cycling power does not rectify the problem, turn the gas off using the manual gas shutoff and contact us for further assistance.